



AQUBE® MV9

Fully automatic XXL fourfold screen / stencil cleaning system with eightfold ASYNCHRO® stainless steel rotor configuration

Cleans screens, stencils and PumpPrints from SMD paste, SMD adhesive, soldering support substances, oil & dust

Capacity: 4 screens / stencils / carriers up to 800 x 940 mm (31,5" x 37")

Part number: 0905AQ9MV12



Certifications:

This system in its basic version was certified for its energy and water saving processing, for easy operability and for the standard integration of comprehensive safety features.

- Two tank system with two separate circuits
- Intelligent network connectivity for implementation in industry 4.0 smart factories
- Fully automatic 4step process: cleaning, MediumWipe®, rinsing, CWA® supercharger compression drying
- Vertical PTFE mounted rotor system with eight asynchronous spray rotors for thorough wetting (no blind spots)
- Short cycle times (approx. 4 min relative cleaning time per stencil / normal contamination) due to placing the cleaning goods close to the spray rotors
- Water free operation possible with a suitable cleaning / rinsing detergent
- Process and service intervals PLC controlled, event issuing and software control via touch screen
- Safe installation close to the production line / screen printer possible; no special protection required
- EDGELESS Design and VARlccess® maintenance access: maximum capacity on a very small footprint

Key applications

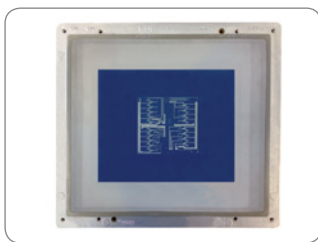

Screens



Stencils

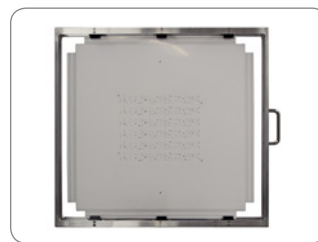

PumpPrints

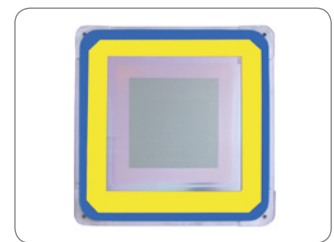

M-Teck stencils

The new kolb AQUBE® series offer next-generation cleaning systems - even more efficient, even more compact, easy to handle and maintain, pre-equipped for extended water management and cyber-physically ready for the smart factory (SF ready).

AQUBE® MV9 is a completely German engineered and manufactured fully automatic XXL system for process safe cleaning of four screens, stencils or PumpPrints in one cleaning cycle. This system with its super-large process chamber can supply up to four printers every quarter hour with freshly cleaned and dried stencils or screens and is therefore ideally suited for large-scale productions with several stencil printers.

The two-tank configuration with two independent circuits and ClosedLoop water reprocessing ensures short cycle times and makes this system the perfect economic choice for the bulk cleaning of stencils..

The cleaning system can be operated with all common electronics cleaning supplies (detergents / chemistry, etc.) which are approved by the manufacturer.





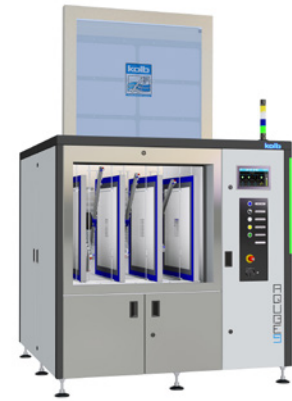

AQUBE® MV9

Fully automatic XXL fourfold screen / stencil cleaning system with eightfold ASYNCHRO® stainless steel rotor configuration

Part number: 0905AQ9MV12



Application overview

Optional suitable	Most suitable	Optional suitable	Not suitable	Not suitable
				
Assembled PCBs Hybrids Misprints	Stencils Screens, PumpPrints Misprints	Solder frames Solder carriers Solder masks	ESD Boxes Containers Magazines	Condensation traps Filters Steel sheets

Optional suitable applications can also be optimally realized with the appropriate options.

Cleaning (key process 1): From the cleaning tank (A) the cleaner liquid is sucked by a magnetically coupled pump unit and routed with a controllable volume flow through a separate circuit into the PTFE mounted ASYNCHRO® stainless steel spray rotors with patented PUSHFORCE® nozzles. Their geometry ensures a comprehensive and thorough cleaning, even in inaccessible and critical areas. After the washing procedure, the valve switchover of the process chamber undocks the cleaning circuit until the next process run.

MediumWipe® (key process 2): The remaining cleaner is blown off from the clean products and blown out of the cleaner circuit and recirculated into the cleaning tank before the valve switchover closes.

Rinsing with tap water (key process 3): From the rinsing tank (tank B / C), the water is pumped through the separate second circuit into the spray rotors. Tap water has (compared to DI / DM water) the advantage of lower surface tension and thus flushes also critical points as low standoffs more efficient.

MediumWipe® (key process 2): The remaining water is blown off from the products and blown out of the cleaner circuit and recirculated into the rinsing tank.

Clear rinsing with DI / DM water (optional process): he DI / DM water is produced from tap water in an integrated MB-cartridge and flushes conducting ions of the previous processes. This process is repeated automatically until the remaining amount of ions falls below the programmed value.

MediumWipe® (key process 2): Blowing off and recirculating the remaining DI / DM water into the rinsing tank.

Drying (Key process 4): The purified products are dried with the patented CWA® (Compressed Warm Air) technology. The built-in special compressor compresses the ambient air. At the same time it collects the kinetic energy (frictional heat) of the paddle wheel in the unit, then presses the heated and compressed air into the rotor nozzles which were already used for cleaning and rinsing. There it blows off (pressure) and evaporates (heat) the residual moisture. This method is energetically and constructively highly efficient, as it uses the "waste heat" of the compressor rotation and the compressed air as driving power for the rotors. In addition, a system equipped with CWA® technology requires no additional hardware and no external compressed air connection for the MediumWipe® process.

Maintenance: The system has a VARAccess® maintenance access system with recessed, variable doors and removable panels. In the maintenance area among others are the pump-out set, the optional re-dosage unit with space for a 25 liter detergent and a 5 l additive container as well as the MB cartridge for DI / DM water processing. Tank levels as well as pressure values and maintenance cycles are monitored by the PLC and displayed on the touch screen.

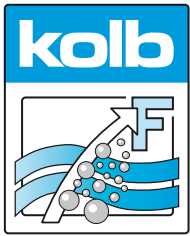

AQUBE® MV9

Fully automatic XXL fourfold screen / stencil cleaning system with eightfold ASYNCHRO® stainless steel rotor configuration

Part number: 0905AQ9MV12



Main standard features

- PowerSpray® technology bundle: magnetically coupled pump unit, eightfold ASYNCHRO® volume-spray rotorsystem with low maintenance PTFE mounted stainless steel rotors with PUSHFORCE® nozzles, "Option101" softwareprogram (101 freely selectable programs)
- PolyPower® XL configuration with XL-Power pump unit
- EATON Programmable Logic Controller (PLC) with module extension for special programming and technology extensions
- Smart Factory ready: DNAccess® (standard) for remote control (see options) and traceability with retractable touch monitor and integrated industrial PC (see options)
- High resolution 10" (1.280 x 800 px) display with capacitive multi-touch and intuitive process view
- Electrically driven large double-wall airlock door: transparent or process-related with internal pane made of stainless steel
- Fourfold alternating LED status light bar integrated in the system frame
- Fourfold slot insert
- Full flow coarse filter (process chamber)
- Fine filter for cleaning circuit
- Sediment filter for cleaning tank (A)
- MediumWipe® unit for further optimization of detergent and rinsing fluid use
- CWA®-supercharger compression drying
- ClosedLoop reprocessing of cleaning and rinsing fluids
- HMA software and pre-equipping for HMA hardware (Heavy Metal Adsorber) for the cleaning circuit (see options)
- Spare space for DI / DM water processing cartridge
- Safety features: safety interlock on the process chamber door, overflow alarm for all tank sections, overheating protection for all heating and drying elements, end switches for all motor-driven valves and drives, personnel protection insulation
- VARlccess® service access with right and left-hinged side doors as well as unhinging possibility for side doors, front panel, and rear supply rail
- EDGELESS housing design. Doors, cover panels and hinges without edges, depot for traceability scanner and monitor in the right side panel
- Process sections made of electrolysis resistant elements



AQUBE® MV9

Fully automatic XXL fourfold screen / stencil cleaning system with eightfold ASYNCHRO® stainless steel rotor configuration

Part number: 0905AQ9MV12



Main options

- Adjustable DI / DM water mixing and blending unit
- AOSelection® bundle to separate mandatory disposable and public sewage network dischargeable rinse water
- Automatic monitoring of ionic residues contamination and gauging of rinse water quality
- Automatic re-dosage unit for 25 l detergent and 5 l additive container
- Carriers for slot inserts
- Descaling unit to reduce the lime content in the rinsing water
- Drip & storage reservoir
- Exchange for rinse water and pump out unit
- Exhaust unit
- Heater for tank A (cleaning)
- HMA filter (Heavy Metal Adsorber) unit for the cleaning circuit
- MB / DI cartridge for deionized (DI) and demineralized (DM) water
- Noise insulation
- Optional lacquering (frame rack and coverings)
- Permanent automatic rotor run control
- Remote Control (remote monitoring, mailing, etc.)
- Status light fivefold to display the current process state
- Traceability unit with PLC data scanner and retractable touch monitor and industrial PC with Intel processor

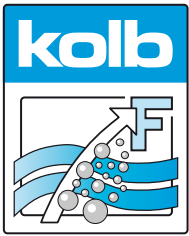

AQUBE® MV9



Fully automatic XXL fourfold screen / stencil cleaning system with eightfold ASYNCHRO® stainless steel rotor configuration

Part number: 0905AQ9MV12

Internal rinse water processing (standard)

Options for water management

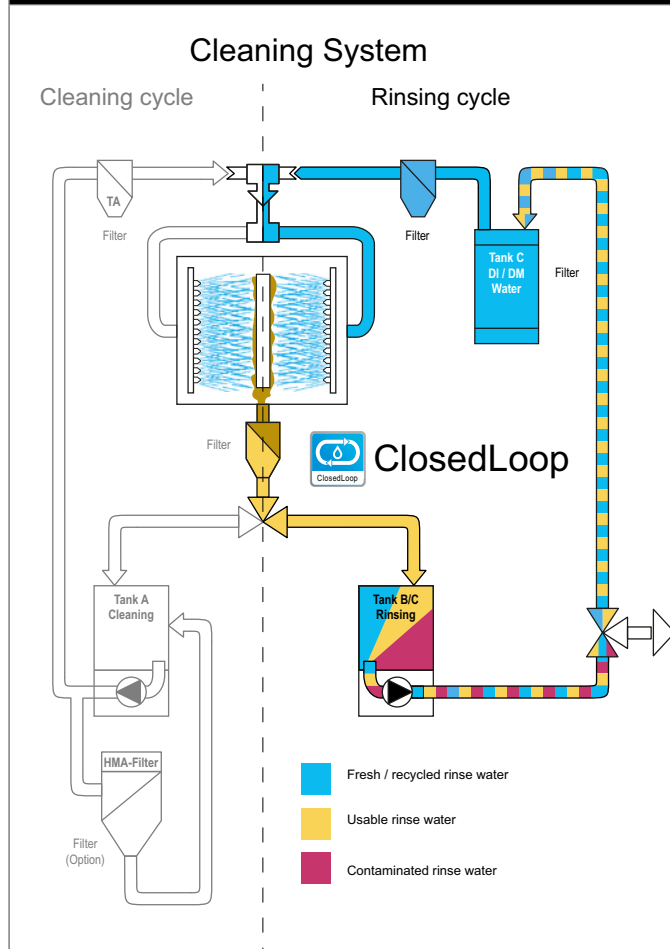

AOSelection® unit

separates mandatory disposable from public sewage network inroducable rinse water.

WPSD IU SYMBIO-module

Processes mandatory disposable sewage water to public sewage network inroducable rinse water.

WPSD 200 system

Processes mandatory disposable sewage water from up to three cleaning systems to public sewage network inroducable rinse water.

WPSD 500 system

Processes mandatory disposable sewage water from up to five cleaning systems to public sewage network inroducable rinse water.

WPCL IUT2 SYMBIO-module

Recycles DI / DM water for recirculation and multiple reuse in the cleaning system clear rinsing cycle.

WPCL 330 system

Recycles DI / DM water for recirculation and multiple reuse in the cleaning system clear rinsing cycle.

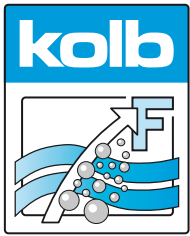

AQUBE® MV9

Fully automatic XXL fourfold screen / stencil cleaning system with eightfold ASYNCHRO® stainless steel rotor configuration

Part number: 0905AQ9MV12



Technical data

Technology base	kolb PowerSpray®
Capacity	4 screens / stencils / carriers up to 800 x 940 mm (31,5" x 37")
Process chamber dimensions	W 970 • D 955 • H 900 mm
Usable chamber dimensions	4 slots: W 77 - 110 • D 900 • H 800 mm
Volume tank A (cleaning)	ca. 100 - 125 l
Volume tank B / C (rinsing)	ca. 100 - 125 l
Power supply	400 V AC, 32 A CEE / 3PH / 50 or 60 HZ
Power consumption	approx. 7.5 kW
Control system	PLC (EATON)
Temperature load	up to 55 °C
Filter system	up to four stage - 1. Full flow coarse filter < 2 mm, 2. Sediment filter inside the tank, 3. 20" fine filter (1 - 100µm - process dependent), 4. HMA filter
Supply connection 1 (tap water)	3/8", hose connection 14 mm (prov. by customer: inlet water quality < 350 µS conductance value (< 10° dH) or option descaling unit)
Supply connection 2 (DI / DM water)	1/4", hose connection 14 mm (DI-net prov. by customer or bridging to tap water)
Rinse water drain connection	3/4", hose connection 25 mm with integrated pump out system
Exhaust connection	Ø 160 mm, exhaust capacity 200 to 300m³ / h
Footprint	1.700 x 1.720 mm
Operating noise	74 dB (A)
Empty weight	920 kg

Top view:
Space requirement cleaning system
(a) = Exhaust 160 mm
(b) = Status light

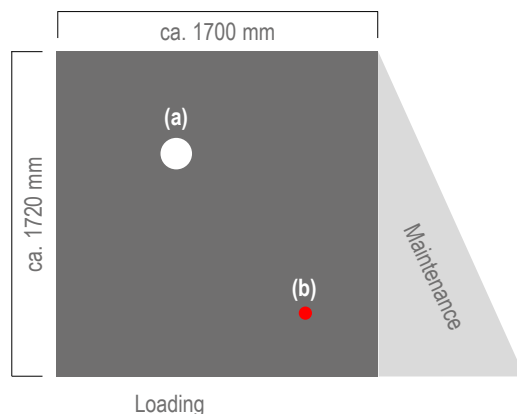

Front view:
with optional status light (b)

